

4CH STANDALONE DVR

USER MANUAL

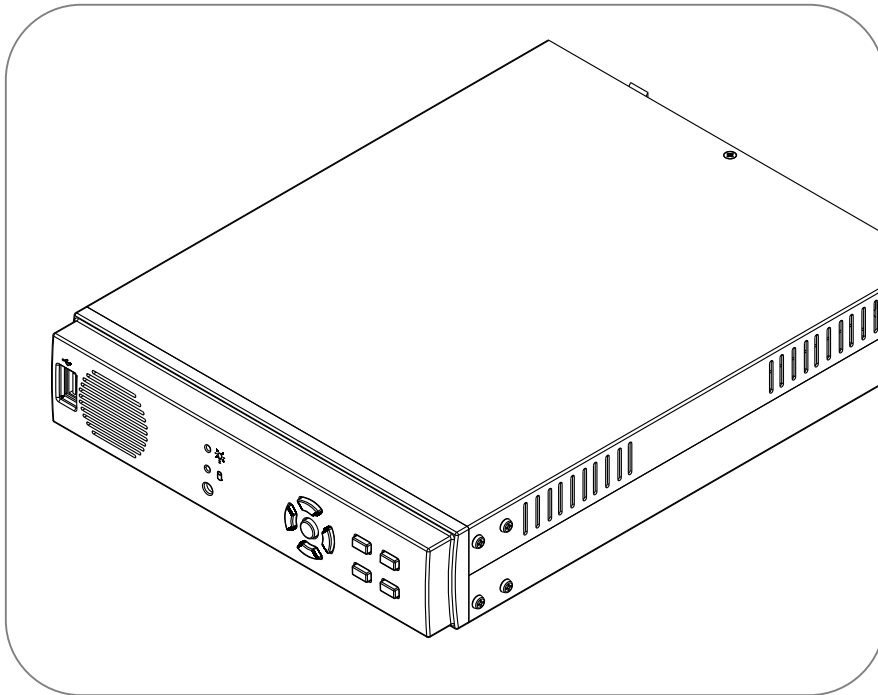

2008 APR. Ver 1.1



空白頁

HDD SUPPORT LIST



Warning :

Should you wish to install a new hard drive in this unit, a list of tested hard drives shown to be compatible can be found below.

SATA

| Brand | Maxtor | Seagate | HITACHI | WD |
|----------|--------|---------|---------|-------|
| Capacity | 160GB | - | 160GB | - |
| | 250GB | 250GB | 250GB | - |
| | - | 320GB | 320GB | 320GB |
| | - | 500GB | 500GB | 500GB |
| | - | 750GB | 750GB | - |

IDE

| Brand | Maxtor | Seagate |
|----------|--------|---------|
| Capacity | - | 160GB |
| | 250GB | 250GB |
| | 320GB | - |



Warning :

The hard drive below is not recommended for this unit

| SATA | | | | IDE |
|----------|--------|---------|-------|-------|
| Brand | Maxtor | HITACHI | WD | WD |
| Capacity | 320GB | 1TB | 160GB | 250GB |
| | 500GB | - | 250GB | 320GB |
| | - | - | 750GB | - |
| | - | - | 1TB | - |

CONTENT

| | |
|---|----|
| 1、FEATURE | 2 |
| 2、SPECIFICATIONS | 3 |
| 3、INSTALLATION | 4 |
| 4、FRONT PANEL | 5 |
| 5、OPERATING MANUAL | 6 |
| 6、VIEW CONTROL | 8 |
| 7、PLAYBACK CONTROL | 9 |
| 8、RECORD CONTROL | 9 |
| 9、4 CHANNEL RECORDING HOURS | 10 |
| 10、DVR Viewer User Guide | 11 |
| 11、REMOTE CONTROL GUIDE(Optional) | 18 |
| 12、SATA TO PATA CONVERT BOARD(Optional) | 19 |

1、FEATURE

- 1、Definitely Standalone.
- 2、Real Time Refresh Rate.
- 3、Display While Recording.
- 4、Frame Recording & Quad Recording.
- 5、Compatible of NTSC/PAL format.
- 6、Advanced MJPEG.
- 7、Manual / Motion / Programmed
- 8、Systems records automatically while alarming.
- 9、Search by Time / Date.
- 10、Watch dog feature.
- 11、HDD Volume Indicator.
- 12、Can use USB to link PC, Player can search Time to Play、
saving and take photos functions.
- 13、Internal motion detect feature.
- 14、Support Audio Recording.
- 15、Remote Control (Option).
- 16、Support XGA Output (Option).
- 17、Support LAN Output (Option).
- 18、SATA To Pata Convert Board (Option).

2、SPECIFICATIONS

| ITEM | DESCRIPTION | | |
|----------------------|--|------------------------------|-------------------|
| Video Format | NTSC/PAL | | |
| System | Embedded RTOS | | |
| VGA OUTPUT | D-SUB 15Pin VGA | | |
| Video Input Channel | 4CH (1Vp-p 75 Ω) BNC | | |
| Video Output Channel | 1CH (Monitor Out) BNC | | |
| Audio Input Channel | 1CH RCA | | |
| Audio Output Channel | 1CH RCA | | |
| Display Frame | NTSC | 120 fields/s (4x30 fps) | |
| | PAL | 100 fields/s (4x25 fps) | |
| Recording Frame | NTSC | Max. 30 fps | |
| Rate (QUAD) | PAL | Max. 25 fps | |
| Recording Frame | NTSC | Max. 7.5 fps (30 fps / 4ch) | |
| Rate(EACH) | PAL | Max. 6.25 fps (25 fps / 4ch) | |
| Recording Mode | Continuous /Motion / Programmed | | |
| Resolution | Display | NTSC | 720x480 |
| | | PAL | 720x576 |
| | Recording | NTSC | 640x224 |
| | | PAL | 640x272 |
| Compression Format | Modified MJPEG | Low | 12K Bytes / Frame |
| | | Normal | 15K Bytes / Frame |
| | | High | 20K Bytes / Frame |
| HDD | IDE HDD x 1 | | |
| Backup Device | USB | | |
| Search | Mode | Time / Date / Event | |
| | Full screen | YES | |
| Alarm Input | NONE | | |
| Motion Detect | YES | | |
| Video Loss | YES | | |
| Auto Switching | YES | | |
| Buzzer Output | YES | | |
| Brightness Adjust | YES | | |
| Contrast Adjust | YES | | |
| USB Output | YES | | |
| VGA Output | YES(Optional) | | |
| Looping Output | NONE | | |
| System monitor | Power recover auto restore record mode | | |
| LAN Card | MPEG4(Optional) | | |
| Power Input | DC 12V / 4A(AC100V~240V 50/60HZ) | | |

3、INSTALLATION

REAR PANEL

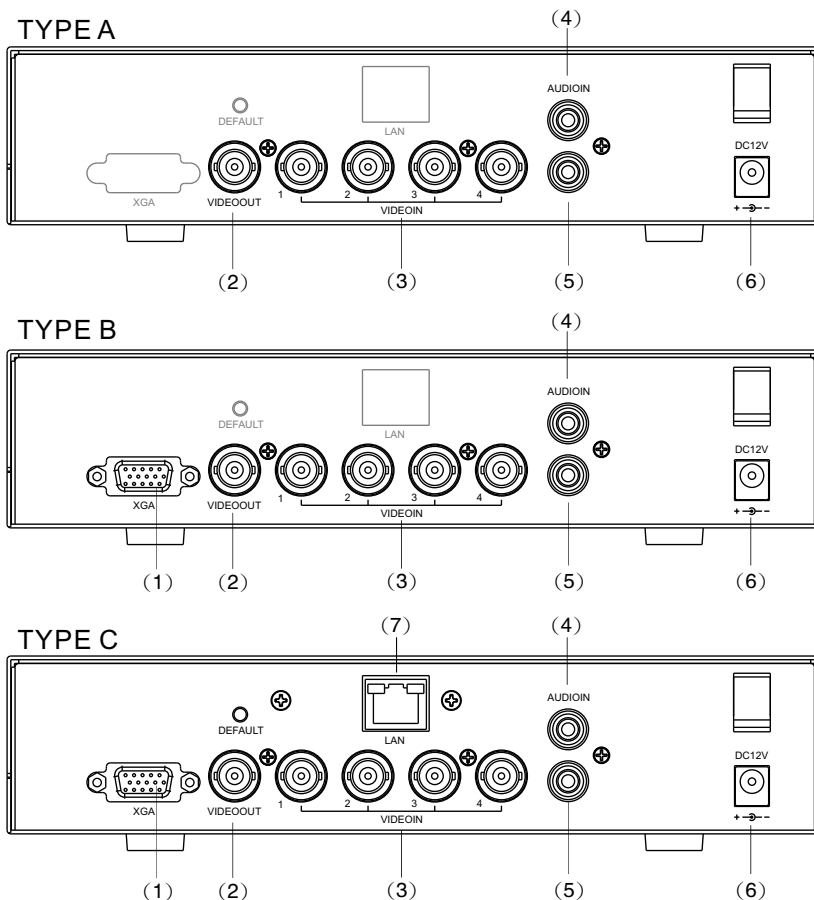

- (1) XGA Output (Option)
- (2) Video Output : Corresponding to Video Input.
- (3) Video IN : Cameras to Video Input.
- (4) Audio Input.
- (5) Audio Output.
- (6) Power Input : Please use the power supply attached
Adaptor : DC-12V / 4A
- (7) LAN Output : (Option)

4、FRONT PANEL

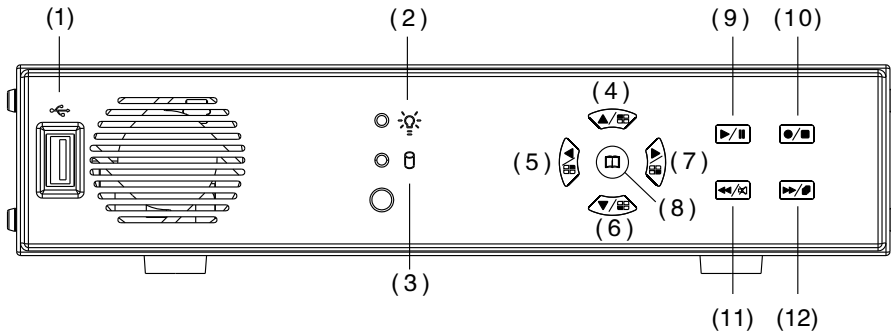

(1) USB PORT

(2) Power Indicator

(3) HDD Indicator

(4) Move Up / Camera 1 Display

(5) Move Left / Camera 2 Display

(6) Move Down / Camera 3 Display

(7) Move Right / Camera 4 Display / Select

(8) Menu / Show Percentage of the hard Drive recorded

(9) Play / Pause

(10) Record / Stop

(11) Fast Reverse / Mute

(12) Fast Forward / Sequence Switch

5、 OPERATING MANUAL (MAIN MENU)

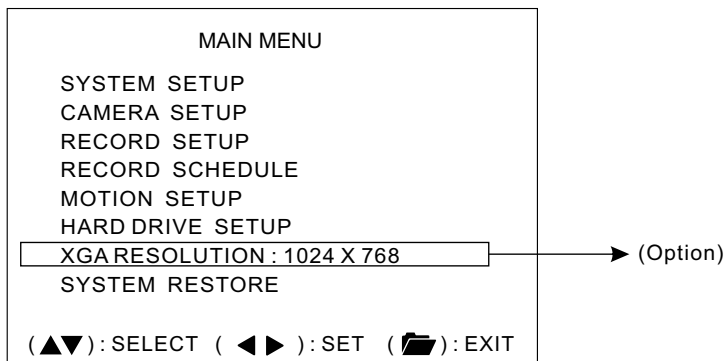

XGA RESOLUTION : 640X480, 800X600, 1024X768 (default setting), 1280X1024.(Option)

Press ▲▼ to select items, use ◀▶ to enter.

Press 🗑️ to exit

SYSTEM SETUP

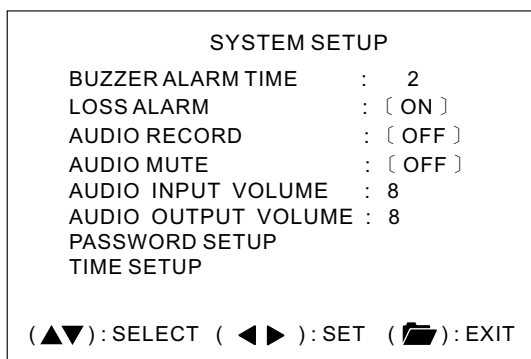

Press ▲▼ to select items, use ◀▶ to enter.

Press 🗑️ to exit

PASSWORD SETUP

Select this item to change password :

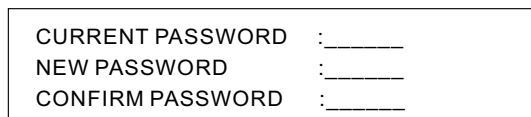

(1) When the new password is accepted, you will receive a message that inform you. PASSWORD CHANGED

(2) If the password was not accepted, you will receive a message that inform you. NO PASSWORD CHANGED

*Use the view control button on the front panel to input the number.

4CH STANDALONE DVR

is:"1" is:"2" is:"3" is:"4"

TIME SETUP

Select this item to set up current time.

| | | |
|---------------------|----------|-----------|
| TIME SET | | |
| 2008/03/16 18:00:30 | | |
| (◀▶):SELECT | (▲▼):SET | (🗑️):EXIT |

Press ◀▶ to select items, use ▲▼ to enter.

Press 🗑️ to exit

CAMERA SETUP

| | | |
|----------------|----------|-----------|
| CAMERA SETUP | | |
| CAMERA | : CH1 | |
| LIVE ON/OFF | : ON | |
| RECORD ON/OFF | : ON | |
| BRIGHT SETUP | : 5 | |
| CONTRAST SETUP | : 5 | |
| COLORS SETUP | : 5 | |
| AUTO SWITCHING | : 2 | |
| (▲▼):SELECT | (◀▶):SET | (🗑️):EXIT |

Press ▲▼ to select items, use ◀▶ to enter.

Press 🗑️ to exit

RECORD SETUP

| | | |
|-------------------|----------|-----------|
| RECORD SETUP | | |
| RECORD MODE | :EACH | |
| VIDEO QUALITY | :NORMAL | |
| RECORD FRAME RATE | :30 | |
| (▲▼):SELECT | (◀▶):SET | (🗑️):EXIT |

Press ▲▼ to select items, use ◀▶ to enter.

Press 🗑️ to exit

- (1) Record Setup:EACH MODE (frame recording),
Each Mode frame rate alternatives as follows:
Maximum : 7.5 fps each camera Totally :30 fps = 7.5 x 4 CH
QUAD MODE (quad recording).
In this mode 、 、 、 invalid.
- (2) Video Quality: video quality selection: High, Normal, Low
- (3) Record Frame Rate(NTSC): QUAD MODE frame rate alternatives as follows:
Enable Audio Record → 30 、 15 、 10 、 7 、 5 、 4 fps.
Disable Audio Record → 30 、 15 、 10 、 7 、 5 、 4 、 3 、 2 、 1 fps.
Record Frame Rate(PAL): QUAD MODE frame rate alternatives as follows:
Enable Audio Record → 25 、 12 、 8 、 6 、 4 fps.
Disable Audio Record → 25 、 12 、 8 、 6 、 4 、 3 、 2 、 1 fps.

RECORD SCHEDULE

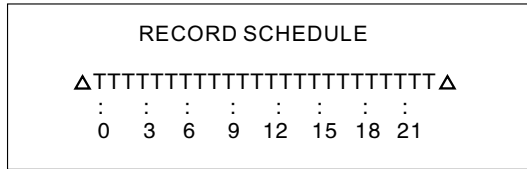

Press ◀▶ to select items, use ▲▼ to enter.

Press ⏏ to exit

- (1)Range: 0-24 hrs.
- (2)Set "T" for continuous recording.
- (3)Set "M" for motion recording.
- (4)Set up "-" to disable the recording.

MOTION SETUP

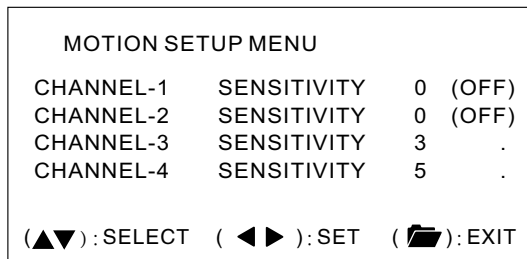

Press ▲▼ to select items, use ◀▶ to enter.

Press ⏏ to exit

★ If you want to enable Motion Recording, Please finish the setup procedure a. and b.

- a. Set SENSITIVITY in the menu option "MOTION SETUP MENU"
- b. Set "PROGRAMMED RECORD" --- "M" in the menu option "RECORD SCHEDULE".



6. VIEW CONTROL

(1)You can use the following view control buttons to monitor the video from the cameras.





- Camera #1 (Ch1), return to Quad Mode by press again.
- Camera #2 (Ch2),return to Quad Mode by press again.
- Camera #3 (Ch3),return to Quad Mode by press again.
- Camera #4 (Ch4),return to Quad Mode by press again.

(2)View Control is only valid while the RECORD MODE is in the EACH MODE. QUAD Display, Enable / Disable theAuto switching function.

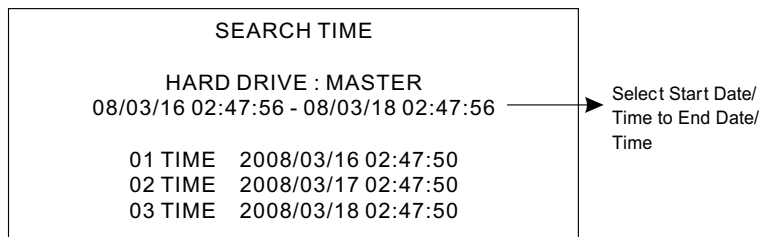
7、PLAYBACK CONTROL

- (1) Press , and the system will play the latest event which you haven't seen before.
- (2) Press , and the system will enter the PLAYBACK EVENTS SEARCH MODE.
- (3) Each period is as four hour.



Press  to select items, use  to enter.
Press  to exit,  select event / time.



Press  to switch between the TIME SEARCH MODE and the PLAYBACK EVENTS SEARCH MODE,

Press  to exit.





(1)EVENTS SEARCH MODE :

Press  choose one period, then press  to play.

(2)TIME SEARCH MODE :

The signal > goes up to the HARD DRIVER: MASTER. Press  to select items. Use  select to change data, Then press  to play.

(3)PLAYBACK :

*Press  to speed forward. Continue to press  and show X2, X4, X8 , playing.

*Press  to rewind the playback.

*Press  to pause.

*Press  to stop.

8、RECORD CONTROL

(1) Press  to start recording.

(2) During recording, the mark * appears in status of overwriting

9、4CH RECORDING HOURS ON 80GB HARD DRIVE

*Thereinafter a rough estimate a table for reference only, recording data quantity can follow an image a variation a rate somewhat different.

| Recording Results in NTSC Format | | | 30 fps | 15 fps | 7 fps | 1 fps |
|----------------------------------|-------------------------|---------------|-----------|-----------|-----------|-------------|
| Video Signal | Display Format | Video Quality | | | | |
| NTSC | QUAD MODE | High | 36Hours | 72 Hours | 144 Hours | 1,080 Hours |
| | | Normal | 48 Hours | 96 Hours | 192 Hours | 1,440 Hours |
| | | Basic | 58 Hours | 116 Hours | 232 Hours | 1,740 Hours |
| | EACH MODE (Full Screen) | High | 64 Hours | 128 Hours | 256 Hours | 1,920 Hours |
| | | Normal | 90 Hours | 180 Hours | 360 Hours | 2,700 Hours |
| | | Basic | 112 Hours | 224 Hours | 448 Hours | 3,360 Hours |
| Recording Results in PAL Format | | | 25 fps | 12 fps | 6 fps | 1 fps |
| Video Signal | Display Format | Video Quality | | | | |
| PAL | QUAD MODE | High | 38 Hours | 76 Hours | 152 Hours | 950 Hours |
| | | Normal | 48 Hours | 96 Hours | 192 Hours | 1,200 Hours |
| | | Basic | 60 Hours | 120 Hours | 240 Hours | 1,500 Hours |
| | EACH MODE (Full Screen) | High | 62 Hours | 124 Hours | 248 Hours | 1,550 Hours |
| | | Normal | 90 Hours | 180 Hours | 360 Hours | 2,250 Hours |
| | | Basic | 118 Hours | 236 Hours | 472 Hours | 2,950 Hours |

10、DVR PC Viewer User Guide

Introduction

This document is the Operation Manual for the 4 CH Stand Alone DVR PCViewer.

The application will show you stream image stored in the Storage Device (HDD, CF card, USB Memory Stick, etc.), which was previously formatted and recorded by the DVR.

If any DVR-formatted Storage Device is connected to your PC, the application will automatically detect the Storage Device and show the recorded stream. You can also save the current screen to a JPEG file, and save the video/audio stream to a file [MYS file, the Vineyard's proprietary video/audio stream file format.

The application consists of two functional modules:

- ▶ DVR PC Viewer Shows stream stored in the DVR Storage Device.
- ▶ MYS File Player Plays captured stream file.

Terms in This Document

| | |
|--------------------|--|
| Storage Device | Hard Disk, CF Card, USB Memory Stick |
| The Application | DVR Storage Device PC Viewer |
| DVR Storage Device | Storage Device which was previously formatted and recorded by the DVR base on Vineyard Technologies' DVR chip. |
| OS | Operating System |
| CPU | Central Processing Unit |
| RAM | Random Access Memory |
| GUI | Graphic User Interface |

Requirement

| | |
|---------|---|
| OS | OS of your PC should be Windows 2000(SP4) / XP(SP2) or later. |
| DirectX | Your PC should be equipped with DirectX 7.0 or later. |

Recommendation

| | |
|-----------------------|---|
| Operating System (OS) | The application runs only on Windows 2000 (SP4) / XP (SP2) or later |
| CPU | 1.0 GHz or Higher. |
| RAM | 256 MByte or greater. |

■ Installation

A. Hardware Installation

Before executing the application, connect the DVR Storage Device to the IDE cable of your PC directly, or via USB adaptor

B. Software Installation

Run Setup.exe in the CD-ROM and follow the instruction to finish the installation.

[Make sure that the OS of your PC is Windows 2000 SP4/Windows XP SP2 or later.

■ Execution

Just double click the icon of PC Viewer. The application will try to detect physical storage devices installed at your PC and search for DVR storage device(s) among them.

If there is DVR Storage Device, the application will automatically start playing. However, If the application fails to detect DVR Storage Device, which means that there is no DVR Storage Device installed to your system, it will show following error message and set the default working mode to MYS PLayer (See Section. 4).



Fig.1. No DVR Storage Device Message

■ Shortcut to play the video files on your PC via the attached USB cable:

- a. Connect USB cable both ends to the USB port of the DVR and your PC.
- b. Supply 12VDC power to the DVR.
- c. Wait until the message of USB detected pops up on the VGA monitor.
- d. Run the PC Viewer software accordingly.
- e. Wait until the very first image comes up to the PC Viewer.
- f. Click "Play" icon on the control panel of the PC Viewer to start viewing the video files.

■ DVR PC Viewer

A. User Interface

The default page of the application is DVR Storage Device PC Viewer. The user interface is shown in Fig.2.

4CH STANDALONE DVR

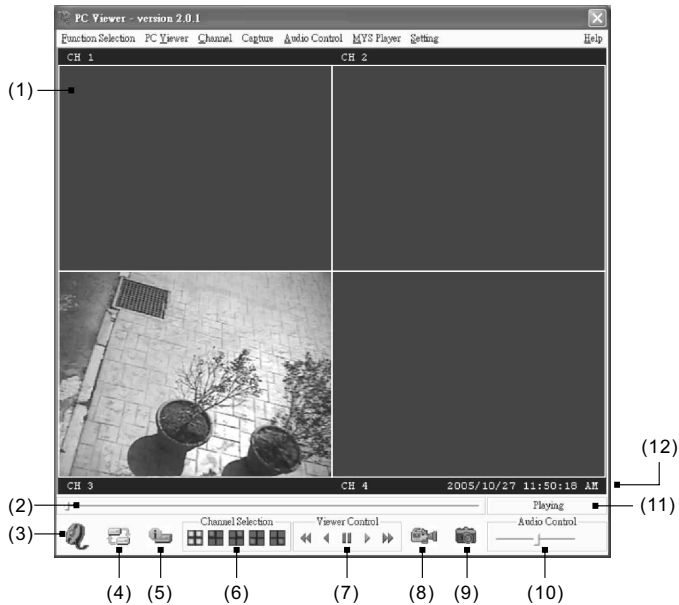

| | |
|--------------------------------------|----------------------------------|
| (1) Screen | (7) PC Viewer Playback Control |
| (2) Positioning Slider Bar | (8) Capture Stream Button [MYS] |
| (3) MYS Player Button | (9) Screen Capture Button [JPEG] |
| (4) DVR Storage Device Change Button | (10) Audio Control |
| (5) DVR Storage Device Information | (11) Viewer Playback Mode |
| (6) Channel Selection | (12) Stream Time Display |

Fig.2. DVR Storage Device PC Viewer User Interface

B. Functions

i. MYS Player Button

If you want to see MYS file which was stored in your PC, press this button or press [F2] key.

ii. DVR Storage Device Change Button

When there are more than one DVR storage devices, this button will be activated. Press this button when you want to see video/audio stream stored in other DVR storage device. Fig.3 shows DVR storage device selection window.

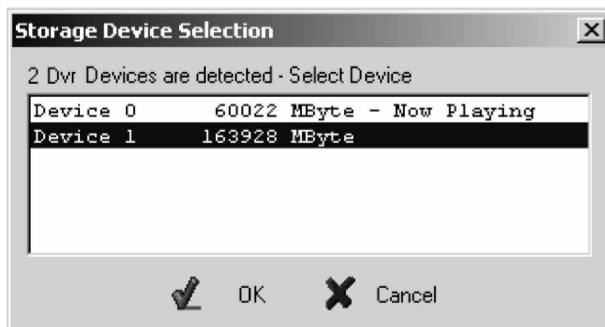

Fig.3. DVR Storage Device Selection Window

iii. DVR Storage Device Information Button

If you want to know how big is the DVR storage device is, or how much stream data is stored in the device, press this button. Fig.4 shows the DVR storage device information window.



Fig.4. DVR Storage Device Information Window

iv. Channel Selection Buttons

According to the record channel setting of the stream, each channel buttons will be enabled. Select any channel you want to see enlarged.





Fig.5. Channel Selection Buttons

Press  button (or [5 or Numpad 5] Key) to see all 4 channels at the same time.

Press  button (or [1 or Numpad 1] Key) to see channel 1 enlarged.

Press  button (or [2 or Numpad 2] Key) to see channel 2 enlarged.

Press  button (or [3 or Numpad 3] Key) to see channel 3 enlarged

Press  button (or [4 or Numpad 4] Key) to see channel 4 enlarged.

v. Viewer Control Buttons

Use Viewer Control Buttons to control viewer playback.



Fig.6. Viewer Control Buttons

*Press  button (or [<-] Key) to start fast reverse playback. By pressing this button again, you can adjust the speed. The maximum speed is 8 times faster than reverse playback.

*Press  button (or [<-] Key) to start reverse playback.

*Press  button (or [Space Bar]) to pause playback.

*Press  button (or [->] Key) to start normal playback.

*Press  button (or [->] Key) to start fast forward playback. By pressing this button several times, you can adjust the speed. The maximum speed is 8 times faster than normal playback.

vi. Capture Stream Button

If you want to capture stream, follow the stream capture procedure listed below:

- * Using Positioning Slider Bar find the stream position you want.
- * Make sure that the playback is in PAUSE mode, and the Capture Stream Button is enabled.
- * Press the button, then the application will start capturing. During capturing, Capturing Indicator Window will be popped up.

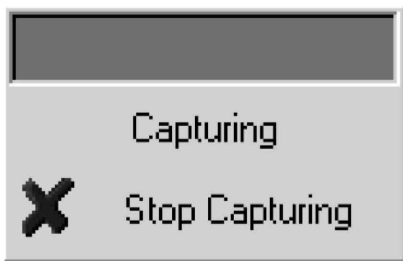

Fig.7. Capturing Indicator Window

- * To stop capturing, press Stop Capturing button on the window.
- The captured file (an MYS file) will be stored in the Capture Directory. See the Application Setting Section, to know more about the Capture Directory setting.

vii. Screen Capture Button



If you want to capture the screen, follow the screen capture procedure listed below:

- * Using Positioning Slider Bar find the stream position you want.
- * Make sure that the playback is in PAUSE mode, and the Screen Capture Button is enabled.
- * Press the button, then the application will start to make a JPEG file. When a JPEG file successfully created. The application let you know that the image file is created showing the file name and the Capture Directory path.

viii. Audio Control



Fig.8. Audio Control Buttons

Press  button to enable sound. Once sound is enabled, the button icon will be changed to . Press it to disable sound again. Using the slider bar, you can adjust the volume.

■ MYS Player

A. User Interface

Fig. 9 shows the user interface of the MYS player.

4CH STANDALONE DVR

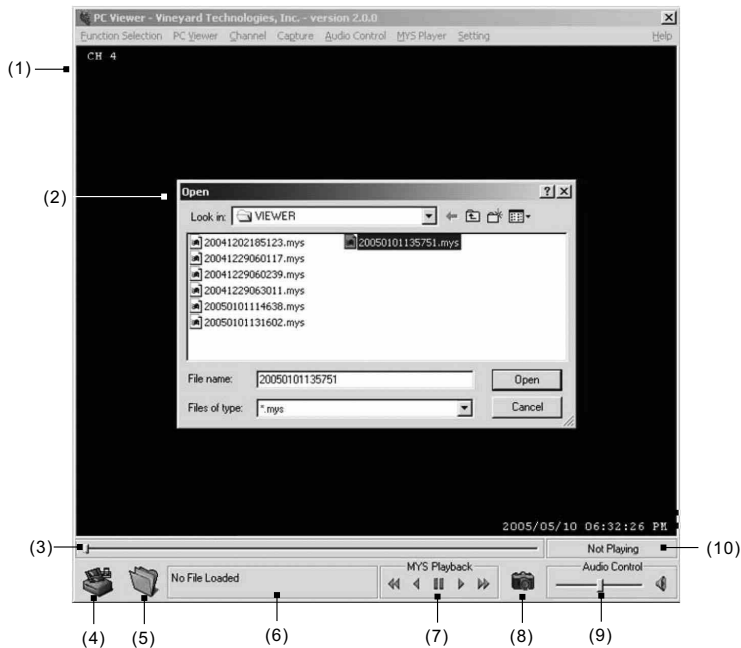

| | |
|----------------------------|----------------------------------|
| (1) Screen | (6) MYS file information |
| (2) MYS File Select Dialog | (7) MYS File Playback Control |
| (3) Positioning Slider Bar | (8) Screen Capture Button [JPEG] |
| (4) PC Viewer Button | (9) Audio Control |
| (5) File Open Button | (10) Playback Status |

Fig.9. MYS File Player User Interface

B. Functions

i. PC Viewer Button

When you want to back to PC Viewer function, press this button.

ii. File Open Button

Press this button to select MYS file.

iii. MYS file information

When an MYS file selected and being played, the file name and the file size will be displayed in the MYS file information box.

iv. MYS file Playback Control Buttons

Use MYS file playback buttons to control the playback.

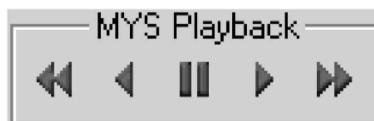

Fig.10. MYS file playback control Buttons

- * Press ◀ button (or [-] Key) to start fast reverse playback. By pressing this button again, you can adjust the speed. The maximum speed is 64 times faster than reverse playback.
- * Press ◀ button (or [-] Key) to start reverse playback.
- * Press || button (or [Space Bar]) to pause playback.
- * Press ▶ button (or [=] Key) to start normal playback.
- * Press ▶▶ button (or [=] Key) to start fast forward playback. By pressing this button several times, you can adjust the speed. The maximum speed is 64 times faster than normal playback.

v. Screen Capture Button

If you want to capture the screen, follow the screen capture procedure listed below:

- * Using Positioning Slider Bar find the stream position you want.
- * Make sure that the playback is in PAUSE mode, and the Screen Capture Button is enabled.
- * Press the button, then the application will start to make a JPEG file. When a JPEG file successfully created. The application let you know that the image file is created showing the file name and the Capture Directory path.

vi. Audio Control



Fig.11. Audio Control Buttons

Press button to enable sound. Once sound is enabled, the button icon will be changed to . Press it to disable sound again. Using the slider bar, you can adjust the volume.

■ Application Setting

A. User Interface

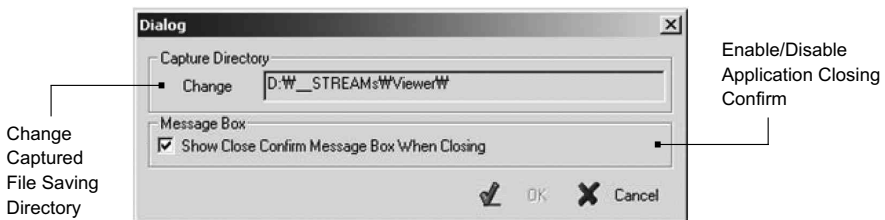

Fig.12. Application Setting Dialog

B. Functions

i. Capture Directory

You can specify Capture Directory. To change the path, press Change Button, select directory you want, and press OK again.

ii. Message Box

You can enable/disable the application close confirm message box.

11 · REMOTE CONTROL GUIDE (Option)

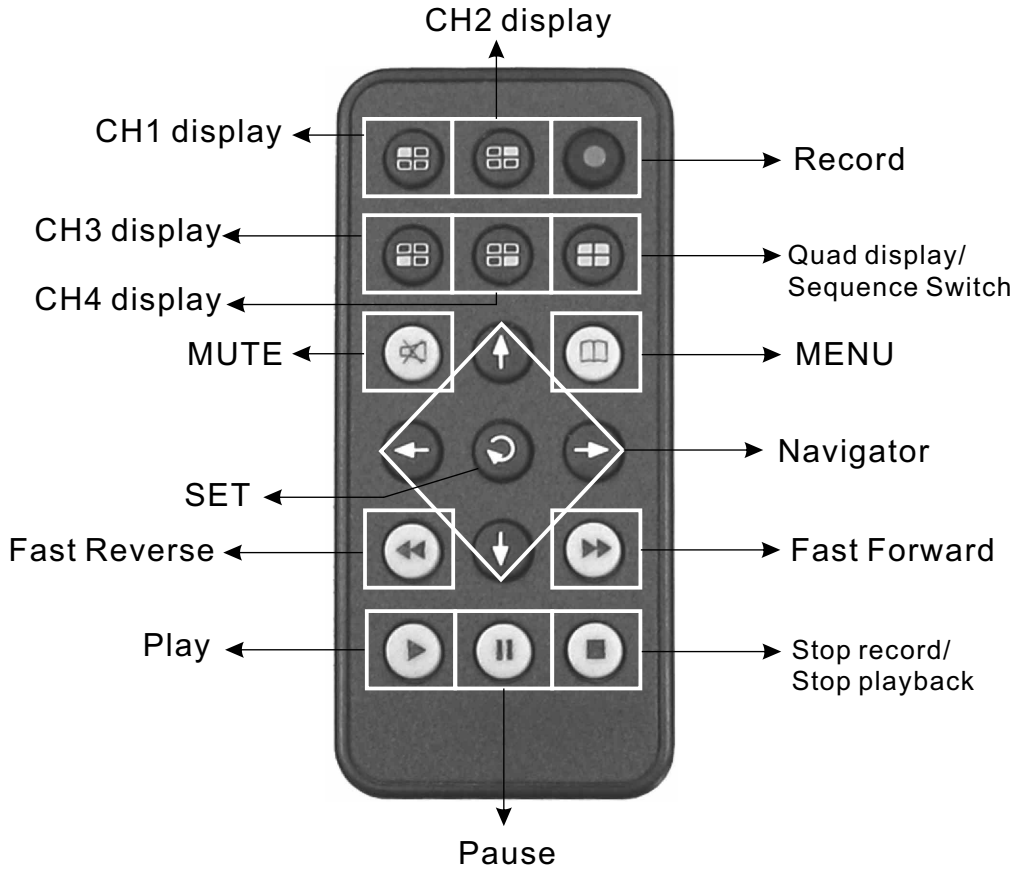

12、SATA TO PATA CONVERT BOARD (Option)

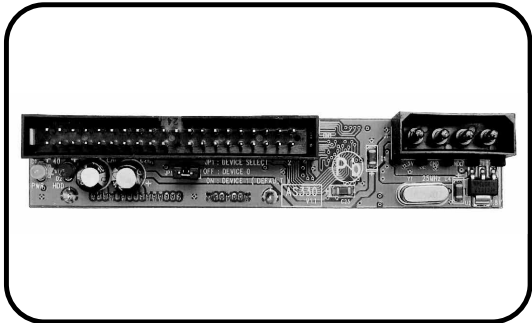

Foreword

This is a SATA convert PATA interface PCB board, before using the product, please read this manual carefully for further recognizing for the product!

I. Key Feature

- Convert SATA TO PATA interface
- Transfer rate max up to 66/100/133MB/sec
- No SATA HDD capacity limited
- LED indicators for Power(green) & HDD(red)
- Compact JBOD (Big) special function.

II. Hardware and Install

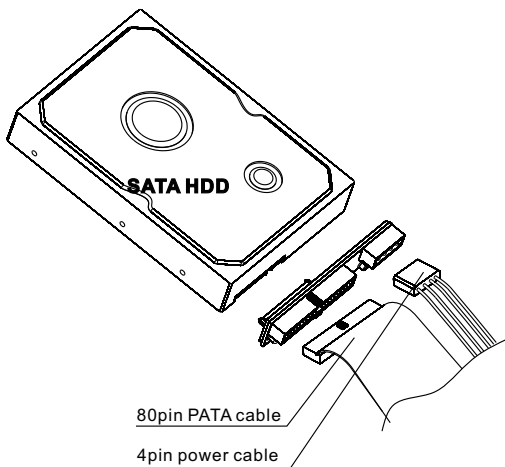
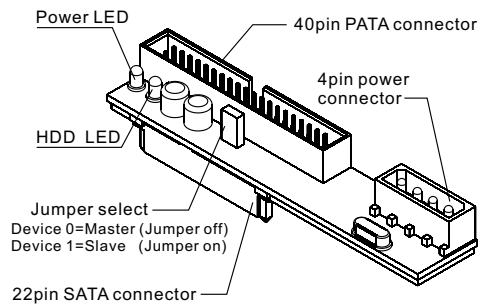

III. Jumper setting for Master & Slave

1. One PATA cable with one SATA HDD then Jumper setting in Master (Jumper off)
2. One PATA cable with two SATA HDD then Jumper setting in one is Master (Jumper off); and another is Slave (Jumper on).
3. Using JBOD (Big) special function.
 - a.) One PATA cable with two SATA HDD then Jumper setting same as step 2.
 - b.) Two PATA cable, each cable with one SATA HDD then these two Jumpers always setting in Master (Jumper off)

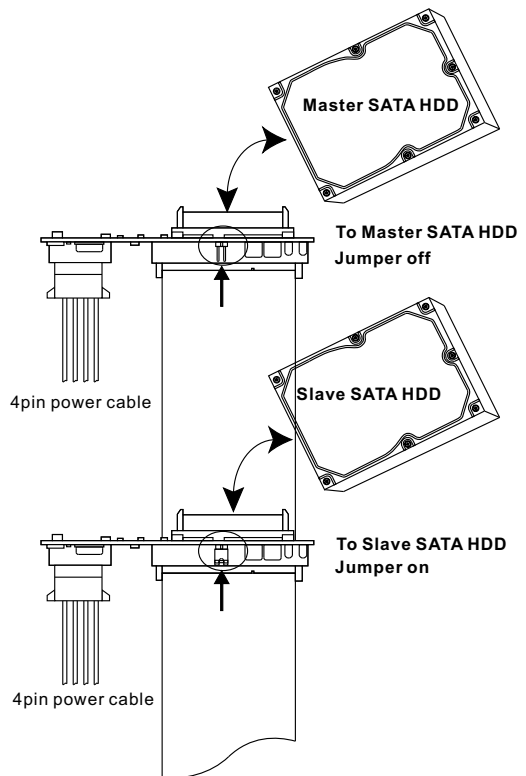

4CH STANDALONE DVR

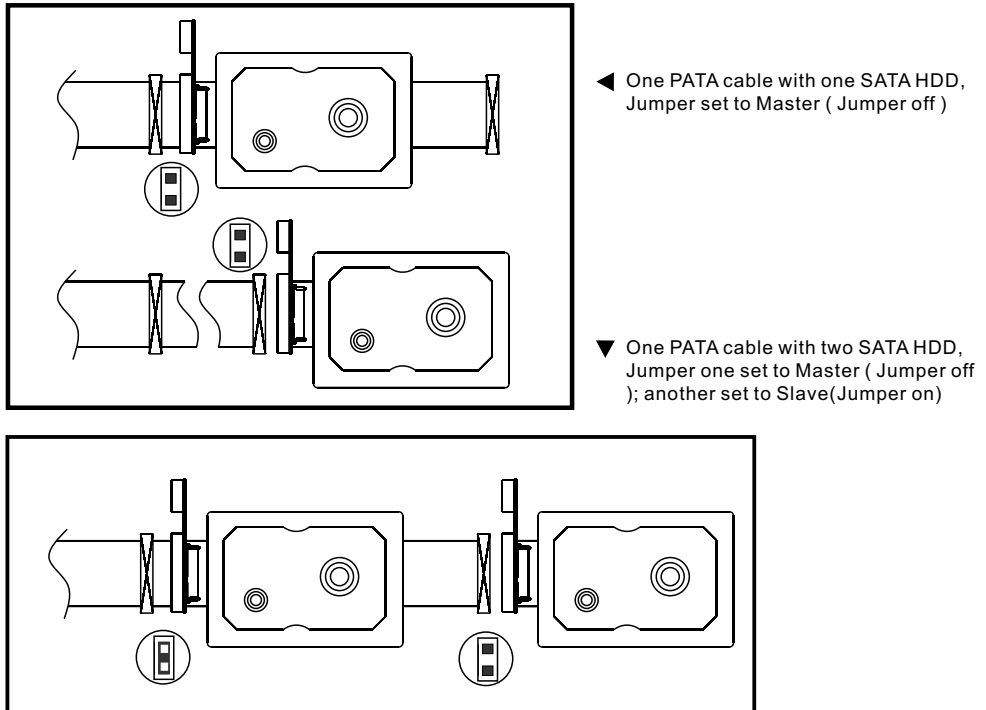

Using JBOD (Big) special function

- ▼ One PATA cable with two SATA HDD, Jumper one set to Master (Jumper off); another set to Slave(Jumper on)

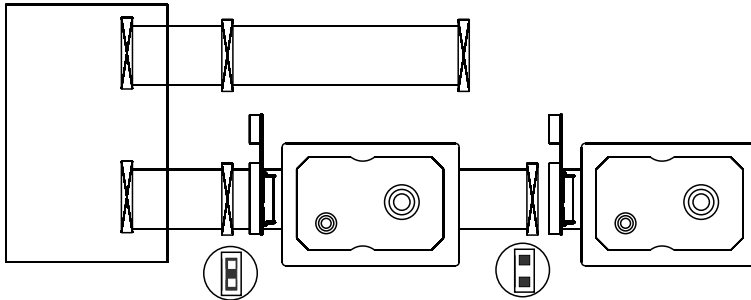

- ▼ Each one PATA cable with one SATA HDD, Jumper all set to Master (Jumper off)

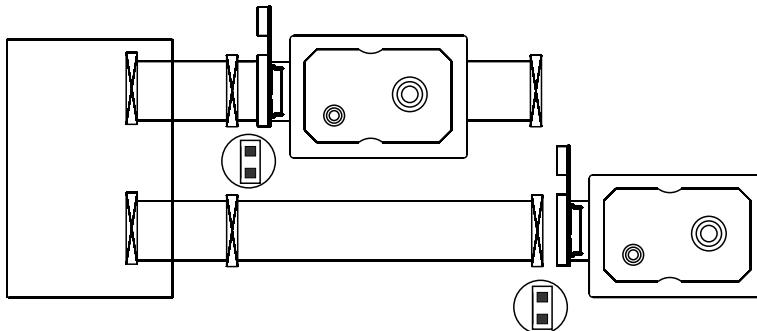

H12C420V03